

ZAZA 2 DOUBLE DELTA

Pour jeux / for games

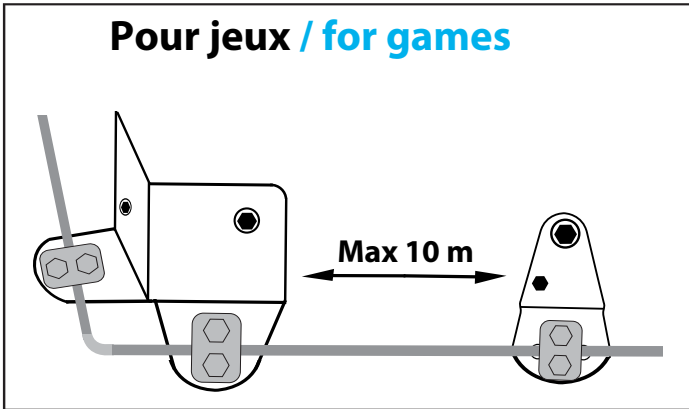

AVANTAGES:

- SPÉCIAL STRUCTURE ARTIFICIELLE / SPECIAL FOR ARTIFICIAL STRUCTURE
- VIRAGES à 90° / REALIZE BENDS OF 90 °
- POLYVALENCE / FLEXIBILITY



Safety Line / Ligne de vie :

ø 12 mm or 1/2 "

Galvanized steel wire rope with metal core /
Câble acier galvanisé avec âme métallique
-7x19
-Non rotating wire rope / Anti-giratoire
-6x26 Swaged/ Compacté

 For any other type: do tests
Pour tout autre type : faire des tests

ZAZA2
JAWS

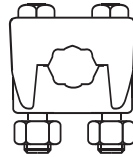

NORMES
EN 15567-1
EN13411-1/7
STANDARDS

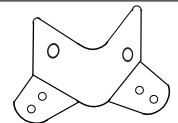

STAINLESS
STEEL
INOX 316L

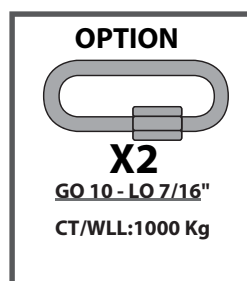
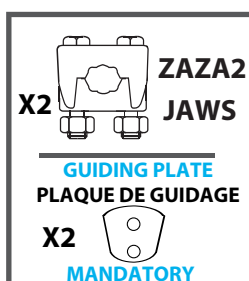
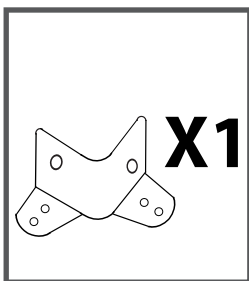

EXEMPLE DE SYSTEME DE FIXATION / EXAMPLE OF FIXING SYSTEM

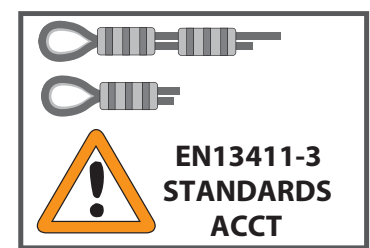
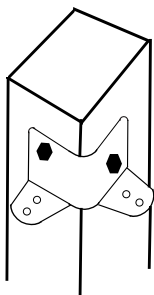

La CMU des fixations doit être correctement dimensionnée / WLL of the fixing element must be correctly sized

Opération 1

RECOMMANDATION OF ASSEMBLY

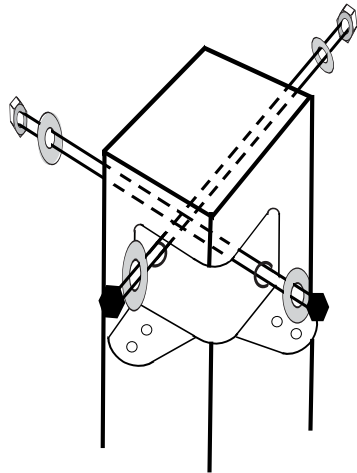

BOLT / BOULON
Ø 12 HR-1/2" HS

THREADED ROD
TIGE FILETÉE
Ø 12HR- 1/2"HS

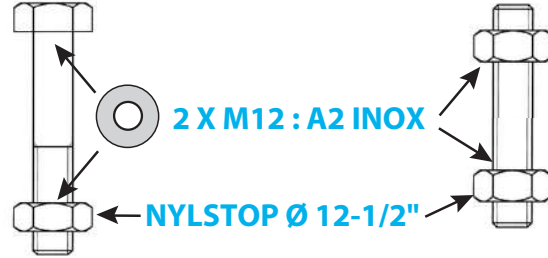

Operation 2

STARTING & ARRIVAL PLATE / PLATINE DE DEPART & ARRIVÉE

EXEMPLES:

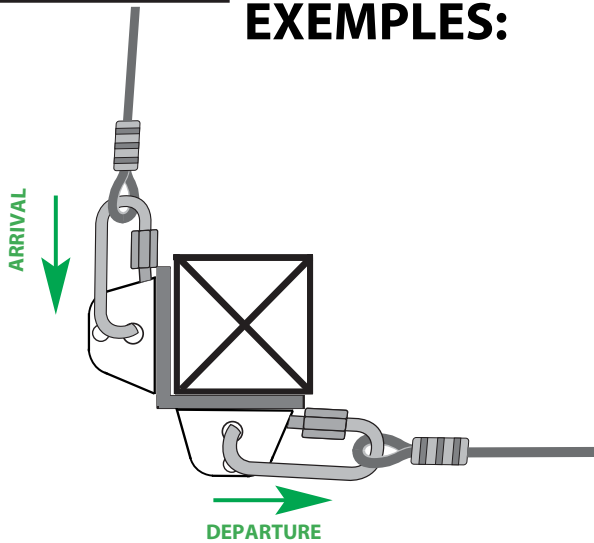

NORMES DE MONTAGE STANDARDS OF ASSEMBLY



EN 15567-1
EN 13411-1/7
STANDARDS - ACCT

X2 MRGO10-LO 7/16"

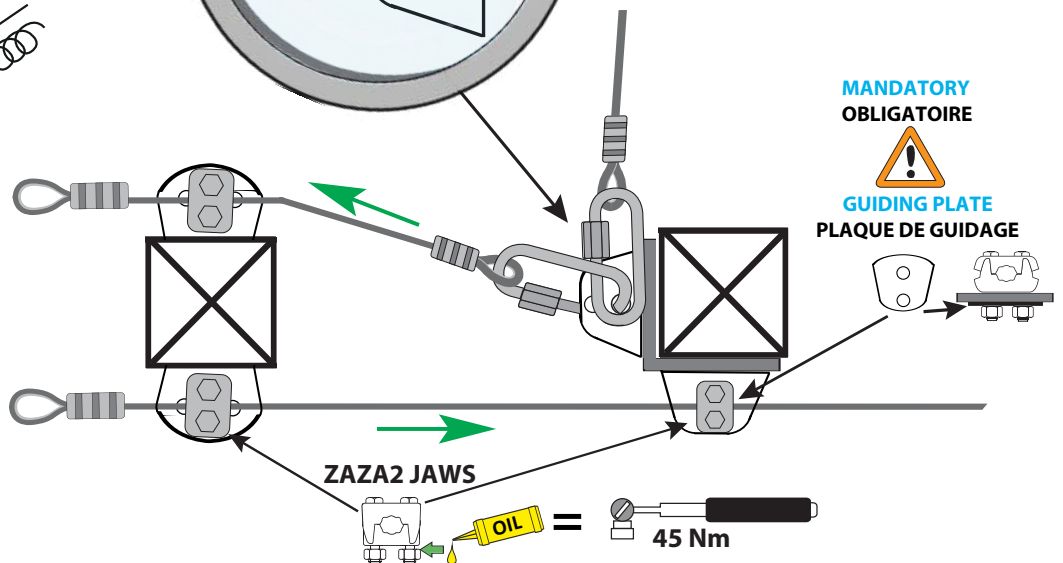
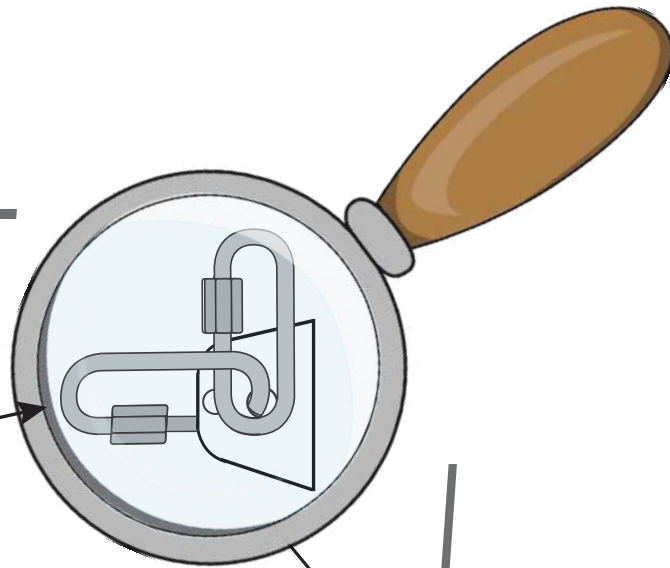

Operation 3

Examples of mounting Combination Exemples de Combinaison de Montage

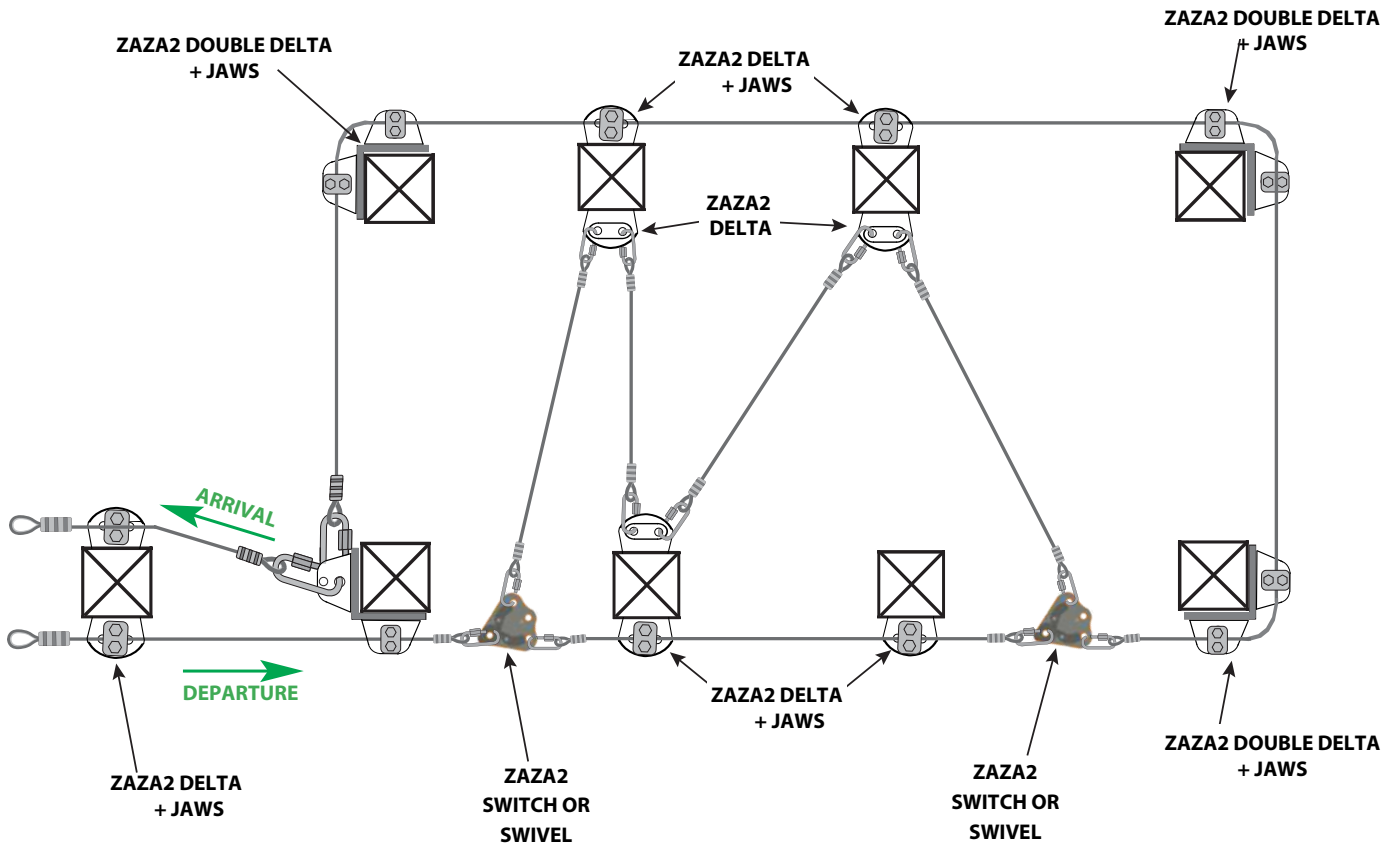

Operation 4

RECOMMANDATION OF ASSEMBLY RECOMMANDATION DE MONTAGE

NORMES DE MONTAGE STANDARDS OF ASSEMBLY



EN 15567-1
EN 13411-1/7
STANDARDS - ACCT

